

MODEL MNLC50 - SIZES 2" THROUGH 8"
LOW CORRUGATION EXPANSION JOINT, 50# CLASS

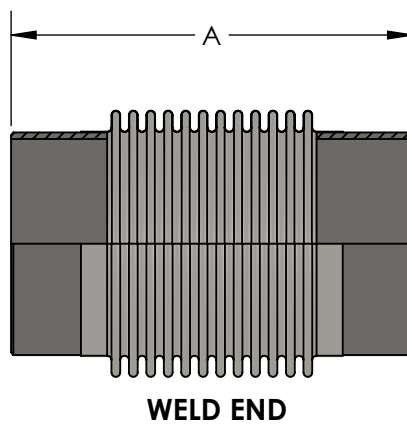
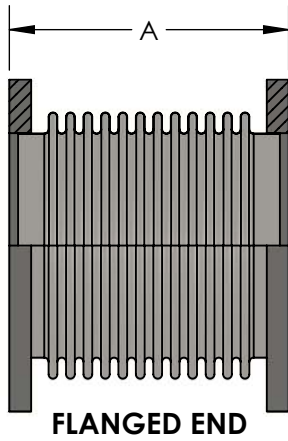

DESIGN DATA

WORKING PRESSURE: 50 PSI
 WORKING TEMPERATURE: 800°F
 TEST PRESSURE: 75 PSI

MATERIALS OF CONSTRUCTION

BELLOWS: 316 STAINLESS STEEL
 150# FLANGES: CARBON STEEL
 WELD ENDS: CARBON STEEL SCH STD

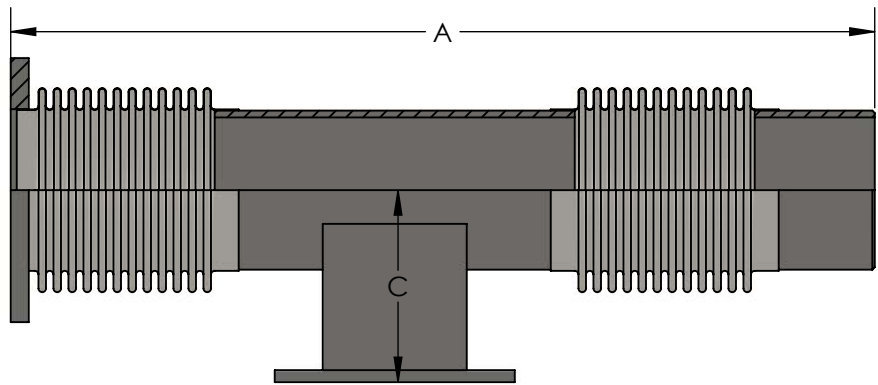

CUSTOM SIZES ARE AVAILABLE.
 CONTACT METRAFLEX FOR DETAILS.
 WHEN ORDERING, SPECIFY MOVEMENT.

DOUBLE WITH ANCHOR BASE (CONTACT FACTORY)

QTY	PIPE SIZE	SHORT / LONG	AXIAL COMP.	FLANGED ENDS		WELD ENDS		EFFECTIVE AREA	SPRING RATE
				OAL	WT	OAL	WT		
	2"	S	1-1/8"	6-1/2"	11 LBS	9-7/8"	3 LBS	6 in ²	590 lbs/in
		L	1-3/4"	8-1/2"	13 LBS	11-3/4"	4 LBS		315 lbs/in
	2-1/2"	S	1"	7"	14 LBS	9-7/8"	3 LBS	9 in ²	498 lbs/in
		L	1-3/4"	8-7/8"	16 LBS	11-3/4"	4 LBS		299 lbs/in
	3"	S	1"	7-3/8"	17 LBS	10-1/2"	5 LBS	12 in ²	345 lbs/in
		L	2"	9"	18 LBS	12"	6 LBS		231 lbs/in
	4"	S	1-1/4"	7-1/2"	27 LBS	10-5/8"	8 LBS	19 in ²	800 lbs/in
		L	2-1/2"	10-3/4"	28 LBS	13-3/4"	9 LBS		399 lbs/in
	5"	S	1-1/4"	7-5/8"	33 LBS	10-5/8"	13 LBS	29 in ²	985 lbs/in
		L	2-1/2"	11-1/4"	34 LBS	14-1/4"	15 LBS		465 lbs/in
	6"	S	1-1/4"	8"	43 LBS	11"	18 LBS	40 in ²	1170 lbs/in
		L	2-1/2"	11-1/2"	47 LBS	14-1/2"	20 LBS		549 lbs/in
	8"	S	1-1/2"	9-1/4"	64 LBS	12-1/8"	22 LBS	66 in ²	1220 lbs/in
		L	3"	13-1/4"	71 LBS	16-1/8"	26 LBS		609 lbs/in

NSF 372 - LEAD FREE

The wetted surface of this product contacted by consumable water contains less than one quarter of one percent (0.25%) of lead by weight. Material complies with state codes and standards, where applicable, requiring reduced lead content.

CUSTOMER: _____

PROJECT: _____

ENGINEER: _____

REV.	DATE
	
2323 W. HUBBARD ST. CHICAGO, IL 60612 TEL: 312-738-3800 FAX: 312-738-0415 WWW.METRAFLEX.COM	
MODEL MNLC LOW CORRUGATION EXPANSION JOINT, 50# CLASS	
DRAWN BY: DKISH	DATE: 2/1/2018
APPROVED: JC	DATE: 2/1/2018
SCALE: NTS	DRAWING NUMBER: MNLC50-2TO8-1